



# Bushfire Roofing Systems

*Design Guide – Steel Roof*



## INTRODUCTION

With a changing climate increasing the occurrence of large bushfires coupled with the increasing population growth and housing demand, the need for a resilient, cost effective and wholistic approach to bushfire design/construction has never been more necessary for the safety of Australians and their property. The FyreROOF system provides the highest benchmark of bushfire fire protection, passing the onerous AS1530.8.2 fire test and receiving a BAL-FZ rating (highest rating possible).

Trafalgar's BAL-FZ FyreROOF System is an assembly of materials that have been chosen specifically with not just fire but also vapour permeability in mind. Unlike other bushfire roof systems that capture moisture within the roof cavity, the FyreROOF system uses a unique vapour permeable fire board called Boardex that allows air and moisture to evaporate out of the ceiling cavity to reduce mould growth, as well as pass the stringent AS1530.8.2 fire testing standard with the highest possible rating of BAL-FZ.

Now that NCC 2022 has been adopted, ALL class 9 (healthcare) buildings MUST be constructed in accordance with AS3959-2018. Trafalgar BAL-FZ Roof System is approved to satisfy these bushfire requirements and has been tested to AS1530.8.2 - 2018 and achieved a BAL-FZ classification result for roof applications. The

Trafalgar also offer the BAL-FZ Wall system has an FRL of -/30/30 when (tested from outside/in), and therefore may be used in Flame Zone (FZ) applications where the vegetation is outside the 10m setback zone.

This manual includes only steel sheet roof applications. For tiled roofs please refer to the **Tiled Roof Design Guide** instead.

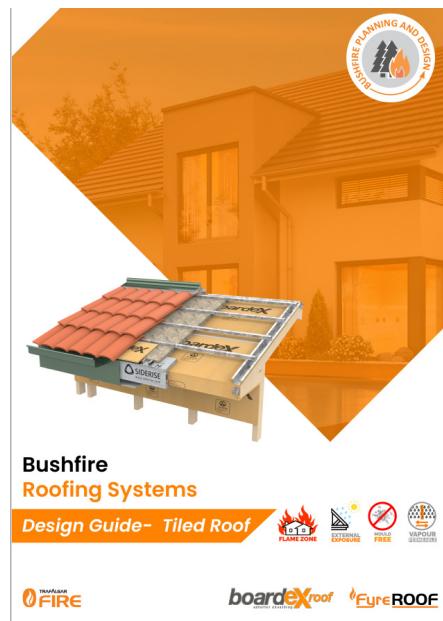

[Click Here](#)

Boardex Roof sheets provides a water tight but vapour permiable envelope that can be left exposed for 12 months during construction

T-Rock thermal insulation provides increased R-value (thermal resistance) for energy efficiency of the home

Various steel sheet profile and tiled roofing options available

Top hats (shown configured for steel roof construction)



Standard Fascia

Standard guttering and barge bracket systems

Fibre cement sheet finish to the eaves

T-Board thermal board protects the eaves and fascia from the hottest parts of the flamezone exposure

Polyurethane fire resistance sealant provides water tight joints during construction



# CONTENTS



Content	Page
Introduction	2
Understanding Bushfire Attack Levels	5
Design For Ventilation	6
Roof System Selection	7
Australian Climate Map	8
Design For Thermal Efficiency	9
Design For Bushfire Attack	10
FyreROOF BAL-FZ Metal Roofs	11
System Range	14
Health And Safety	15
FAQ	15

## UNDERSTANDING BUSHFIRE ATTACK LEVELS (BAL)

Australian Standard AS3959 tells us how to calculate what BAL rating applies to a specific property and what level of construction is needed for the BAL, with the aim of improving its resistance to bushfire attack from burning embers, radiant heat, flame contact and combinations of the three attack forms. BAL ratings range from BAL-0 to BAL-40 and finally BAL-FZ for direct exposure to the bushfire attack (Flame Zone).



Image Source: Bushfire Prone Planning- [What is BAL?](#)

### Trafalgar's FyreROOF system achieves the maximum BAL-FZ rating for roofing applications!

The FyreROOF system is tested to AS1530.8.2, receiving the highest possible BAL rating and is suitable for use in all bushfire areas including the within the Flame Zone:

BAL	Description of Risk	Trafalgar Bushfire Roof System
BAL- LOW	Lowest risk from a potential fire	✓
BAL- 12.5	Risk is primarily from potential embers during a fire	✓
BAL- 19	Moderate risk, particularly from embers and burning debris	✓
BAL- 29	High risk, particularly from embers, debris and heat	✓
BAL- 40	Very high risk. Likely to be impacted by embers, debris, heat and potentially flames	✓
BAL- FZ	Extreme risk. Directly exposed to the flames of a potential fire front	✓

The fire compliance reports and documentation for the FyreROOF system (FAS 230057) is available for download online at [www.tfire.com.au](http://www.tfire.com.au).

## DESIGN FOR VENTILATION

Trafalgar have introduced the BoardeX material to the Australian market because it uses the worlds most advanced vapour permeability technology. The uniquely orange glass matt that coats the mould resistant BoardeX core is designed specifically to prevent liquid water from being able to penetrate the board, whilst also allowing moisture trapped in the air to evaporate through the board. The end result is a roofing envelope that is water and weather tight that allows the ceiling cavity to 'breathe' whereas traditional sarking and plywood products catch the airborne moisture, which condenses and pools within roof cavities leading to rot and mould growth.

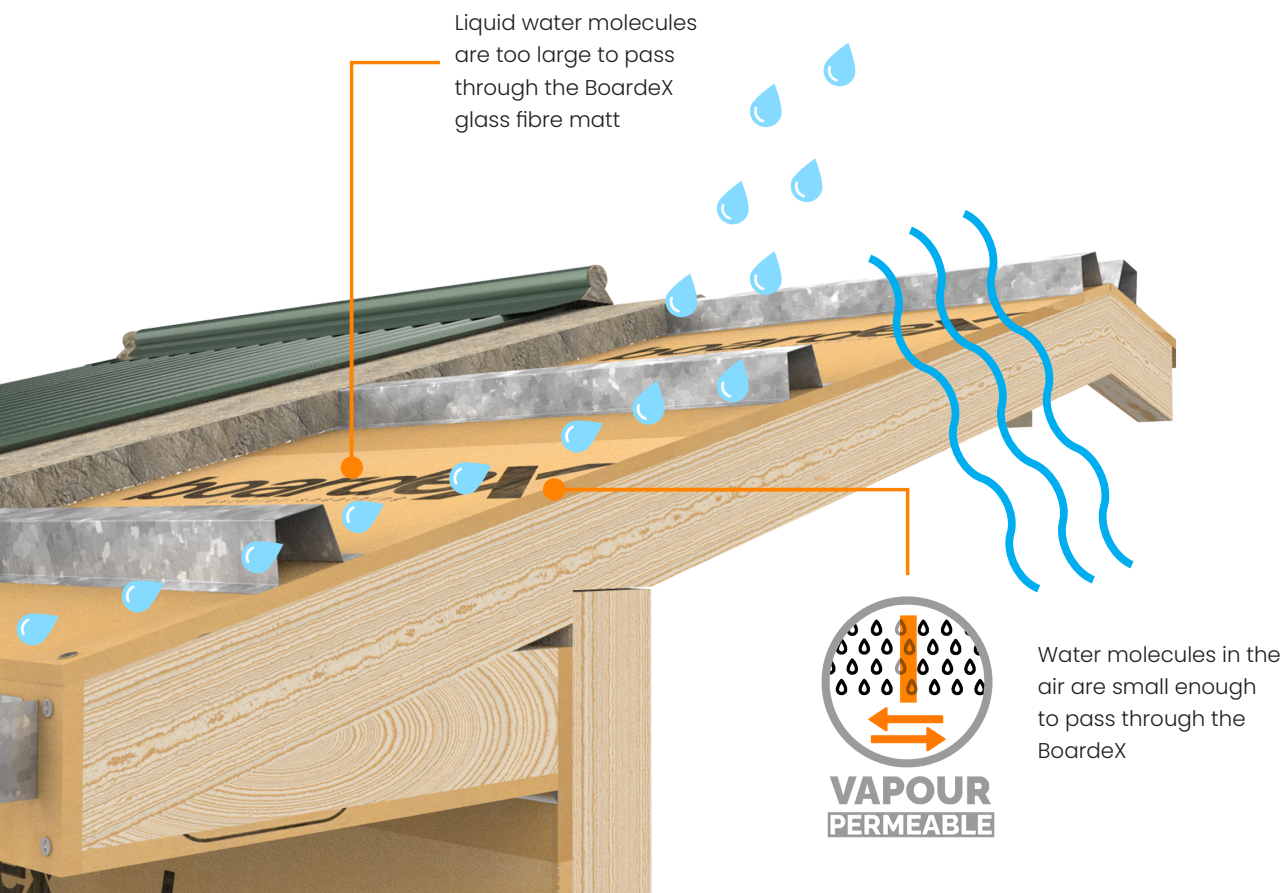

## BENEFITS OF BOARDEx IN ROOF CONSTRUCTION

The BoardeX is used in the construction of exterior roofs and walls worldwide with a moisture-resistant core and damage-resistant glass-fibre matt that can hold staples and screws right at the edge of the board. Boardex can also withstand high temperatures while remaining stable and crack free, providing an ideal product for bushfire fire protection.

BoardeX also permits roofing/walls to be installed as soon as framing is erected, allowing for a dry and weather protected site for quicker construction. It provides a weatherproof envelope to allow internal trades to progress prior to completion of roofing and cladding. BoardeX can be exposed to weathering conditions for up to 12 months without requiring any treatment.



## ROOF SYSTEM SELECTION

To select the compliant roofing system for your project you need to first identify the BAL classification for your site and determine whether your roof will be tiled or metal clad. From there you should also consider design for ventilation and energy efficiency for a wholistic design.

Please note that the following is a guide and Trafalgar recommends that you work closely with your building surveyor/private certifier, fire engineering consultant and insurance provider early in the design phase of your building to ensure compliance where appropriate to your specific building type and project requirements.

The system drawings provided are not drawn to scale and are not intended to be an Installation guide, for further fixing details refer to the specific installation manuals.

# AUSTRALIAN CLIMATE MAP

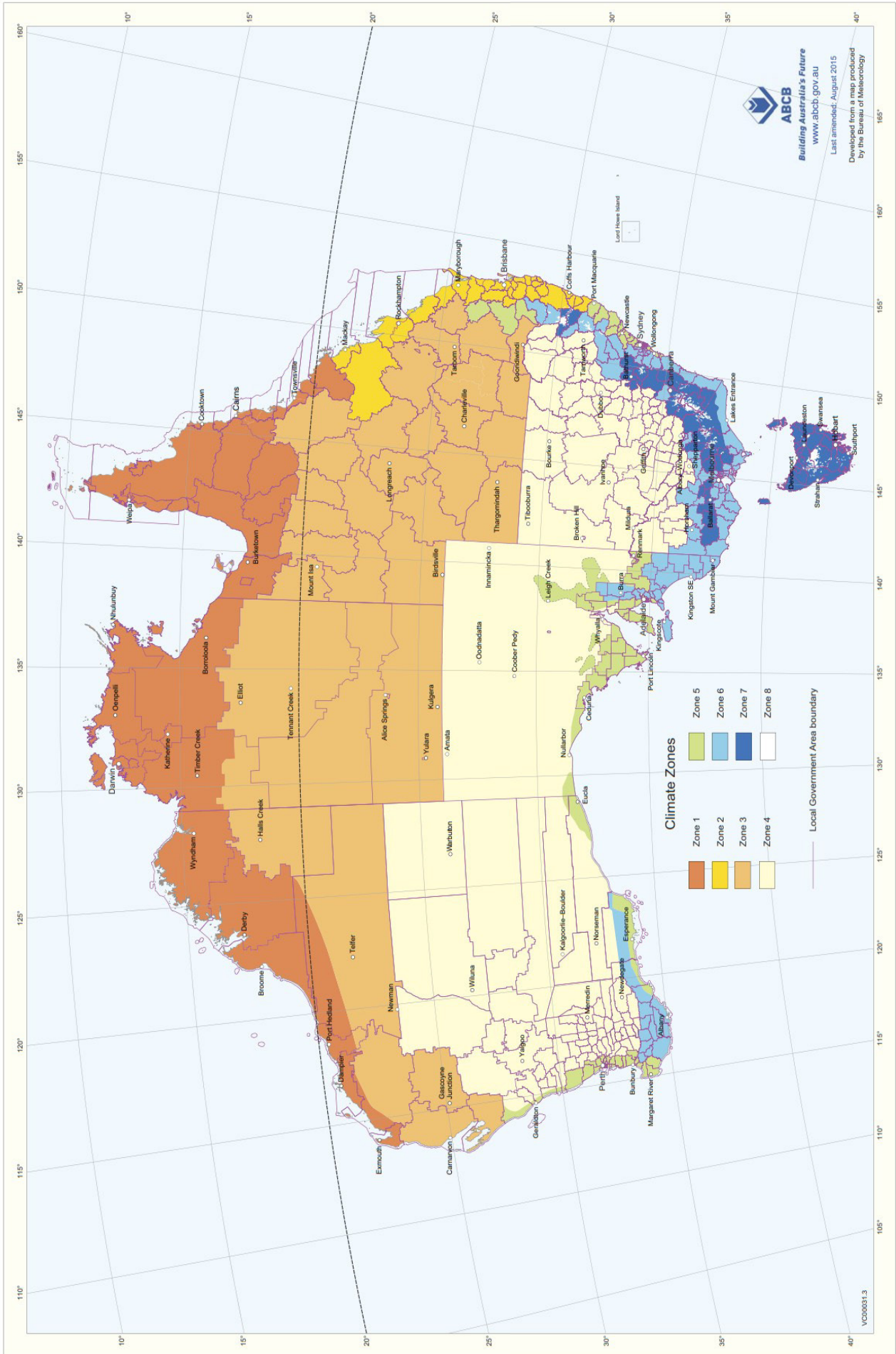

Visit <https://www.abcb.gov.au/resources/climate-zone-map> for an interactive map where you can find what zone your address belongs to.



## DESIGN FOR THERMAL EFFICIENCY

A modern building should be designed holistically with energy efficiency in mind, to improve health and well being of the occupants as well as reducing green house gas emissions and energy bills. A well designed roof/ceiling system can provide high thermal resistance (R-Value) to thermally insulate your house in the winter and summer months. The higher the R-value, the better the building element will perform. The total value can be calculated by adding the thermal resistances of the various roof and ceiling components, including the indoor and outdoor air-films.

The FyreROOF BAL-FZ system provides a higher R-value than traditional roof designs due to the already high thermal resistance of the components used in the roof assembly, reducing the specification needed for additional insulation to be added into the ceiling cavity.

### NCC2022 UPDATED REQUIREMENTS FOR THERMAL EFFICIENCY

There were significant changes to the thermal efficiency requirements for houses constructed under NCC2022 so it is important to know which version of code you need to design for depending on which version of the building code is adopted in your state or territory (although best practice design should consider a more thermally efficient design regardless).

### FyreROOF THERMAL RESISTANCES

Type of FyreROOF	Ventilated cavity, with vapour permiable me- brane (BoardeX)	
	Winter	Summer
Steel Sheet FyreROOF system combined R-value (without additional ceiling insulation):	1.47	1.98
Total R-value With additional R3.0 ceiling insulation	4.47	4.98
Total R-value With additional R4.0 ceiling insulation	5.47	5.98
Total R-value With additional R5.0 ceiling insulation	6.47	6.98

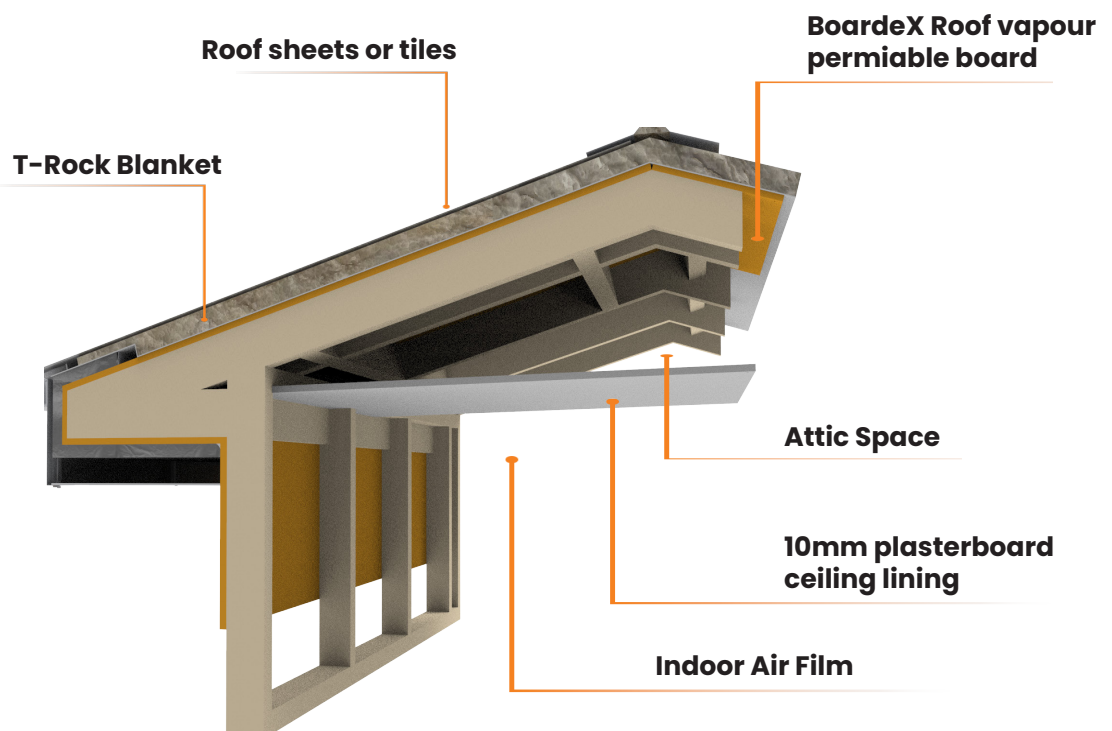

Additional thermal insulations/batts can be added above the ceiling linings to increase the total R-value of the roof system. Refer to the table above for examples.

# DESIGN FOR BUSHFIRE ATTACK

## AS3959-2018

Australian Standard AS3959 tells us how to calculate what BAL rating applies to a specific property and what level of construction is needed for the BAL, with the aim of improving its resistance to bushfire attack from burning embers, radiant heat, flame contact and combinations of the three attack forms. BAL ratings range from BAL-0 to BAL-40 and finally BAL-FZ for direct exposure to the bushfire attack (Flame Zone). Refer to the BAL rating information on page 5 for more information on what each rating means.

Section 3 & 9 of this standard includes the construction and testing requirements for BAL-FZ (Flame Zone) applications, which is the highest level of bushfire attack. AS3959 requires that roofs must be physically tested to, and pass an AS1530.8.2 fire test to receive the BAL-FZ classification. It should also be noted that any system has passed the AS1530.8.2 test is also suitable for any lower level of BAL rating.

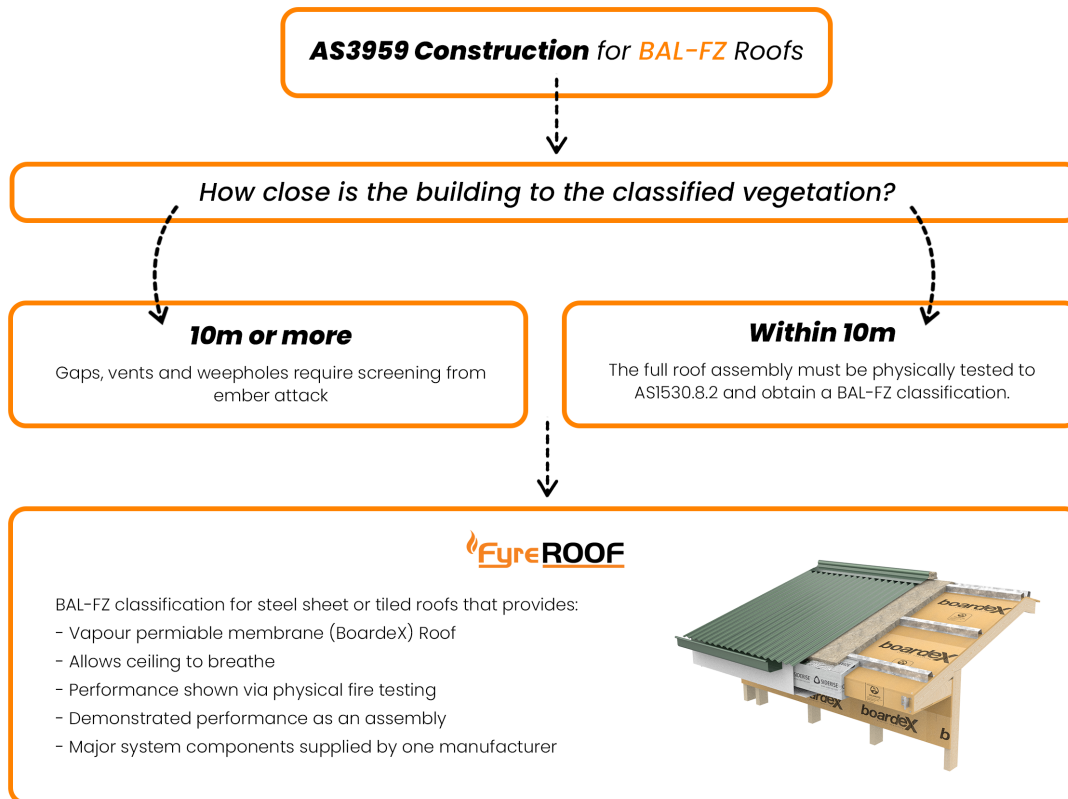

## AS1530.8.2 Fire Testing

This is a fire testing method that must be performed by an accredited testing laboratory whereby a roof assembly (or system) is constructed and installed onto the face of a full scale furnace and burnt for 30 minutes at temperatures up to 840 degrees Celcius. The specimen is then removed from the furnace and observed for an additional 60 minutes to ensure there is no self ignition/flaming.



FyreROOF prior to AS1530.8.2 fire test

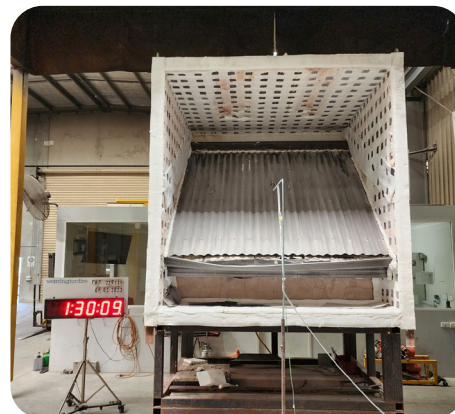

FyreROOF after AS1530.8.2 fire test (BAL-FZ rating obtained)

# FYREROOF BAL-FZ – METAL ROOFS

## FyreROOF system for BAL-FZ metal roofs

#	Roof Component	Roof System Construction Materials
1	Roof sheeting	Colorbond or Zinalume (0.42mm BMT minimum)
2	Battens/top hats	Steel top hats or timber battens
3	Truss	Timber or steel at 600mm centres (additional horizontal and vertical members introduced to back all joints in the Boardex)
4	Rigid Sarking/Vapour Barrier	Boardex 15mm
5	Insulation	T-Rock 50mm, foiled on one side
6	Fascia	Steel fascia mounted with standard brackets and gutters
7	Sarking film	Not required due to Boardex vapour permeable board
8	Fascia/eave protection	T-board 25mm rigid thermal board
9	Weather sealant	T-Stop PU + Sealant applied to all joints between Boardex
10	Eave board	Fibre Cement

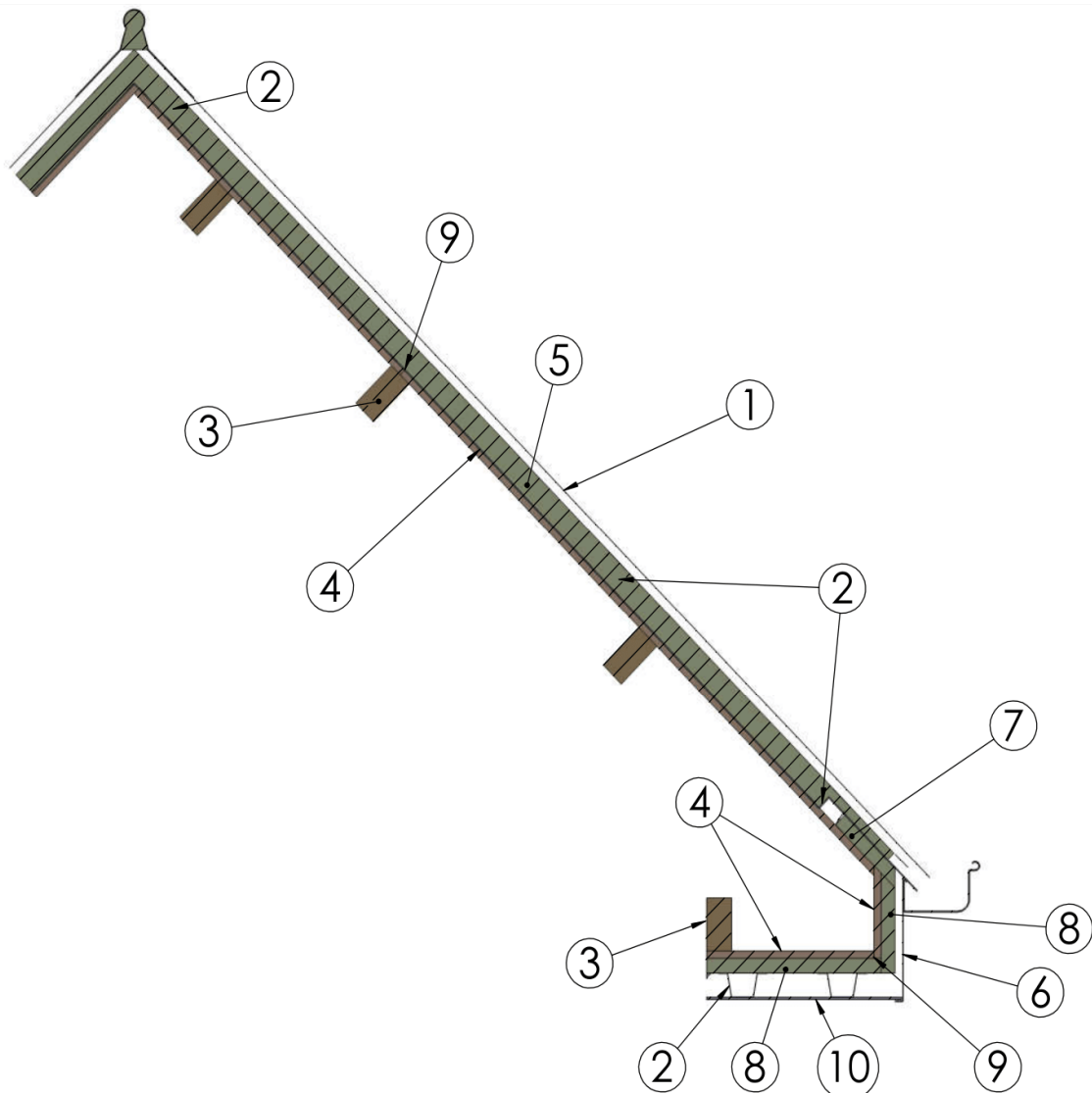

## Figure 1.1 - Boardex weather tight envelope

1. All joints between Boardex to be backed with roof truss (steel or timber frame)
  2. Boardex to be scored/snapped and installed to line the roof & wrap around the eaves and fascia
  3. Boardex fixed into roof truss with staples or screws 5mm from the edges through the re-inforced orange matt, at 200mm centres
  4. Joints between Boardex sanded flat and sealed with T-stop PU+ sealant. All joints in Boardex to be backed with roof truss (timber or steel frame). Joints should be free of dust prior to sealing.
- EXTERNAL EXPOSURE
- Boardex can now be left weather exposed for 12 months providing a weather tight envelope.

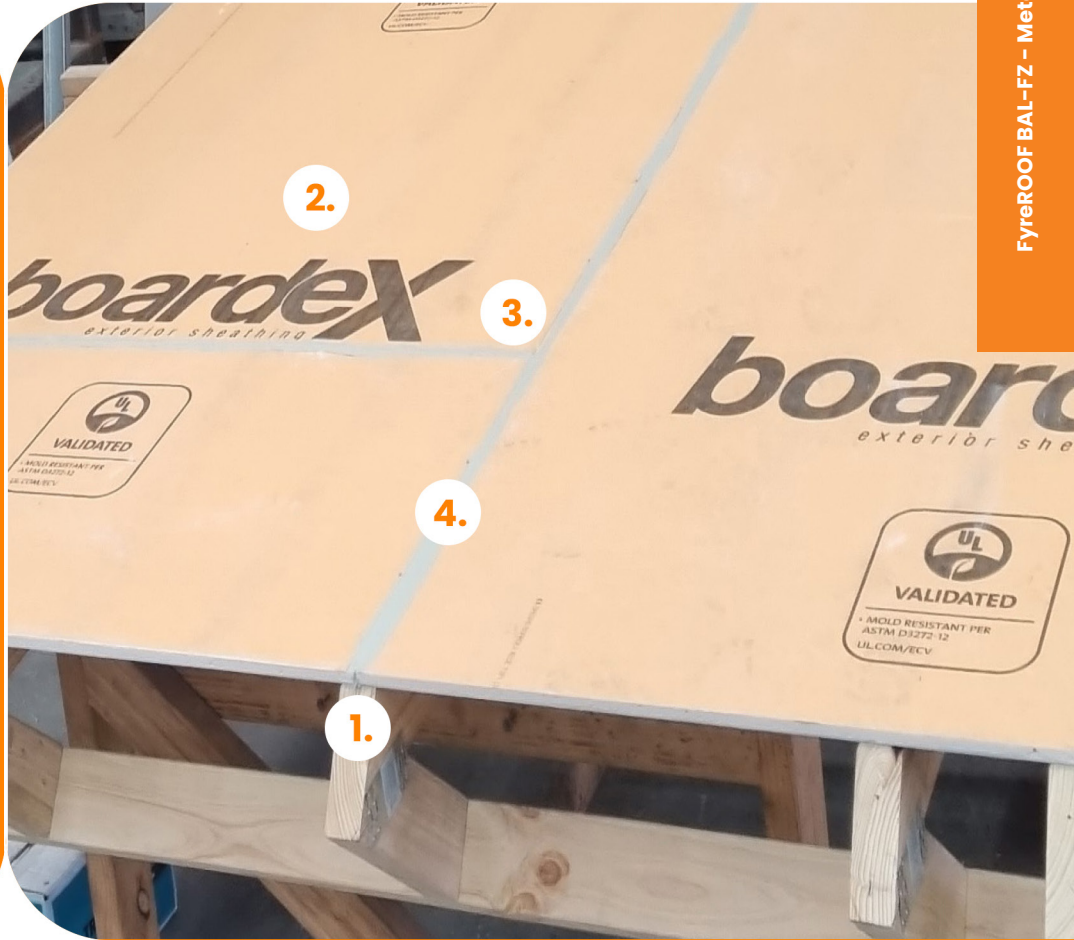

## Figure 1.2 - Fascia, Eaves and Gutter Details

1. Fascia brackets and top hats installed. Top hat/batten installed 100mm from edge of the roof
2. T-Board thermal board wrapped around the eaves/fascia and back onto roof for 100mm to butt into top hat/batten
3. T-Rock thermal lagging laid foil side down over the roof and finished with the foil slightly overhanging into the gutter for drainage
4. Fascia, gutters and eave boards installed with standard clips, brackets and fixings
5. Roof sheets fixed down onto top hats/battens

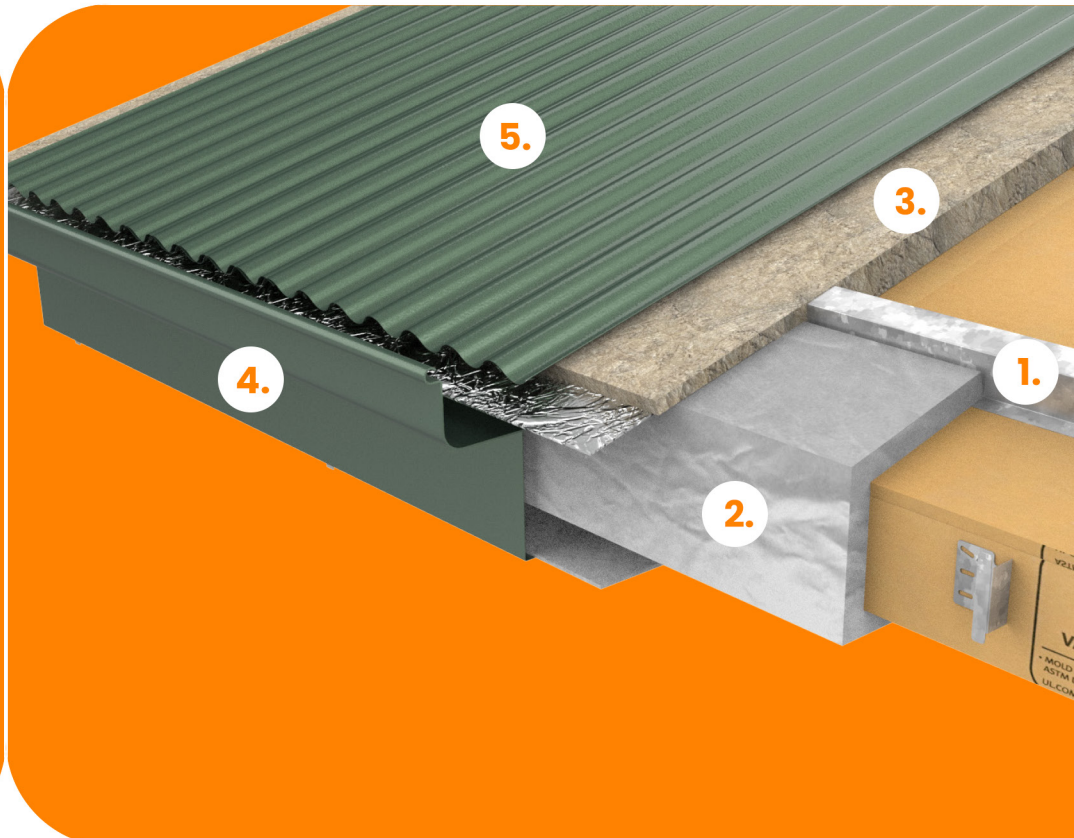

# FYREROOF BAL-FZ – METAL ROOFS (CONTINUED)

## Figure 1.3 – Valley detail

1. Top hats/battens installed vertically up the roof line fixed through the BoardeX into truss below.
2. Space between top hats lined with T-Board thermal board.
3. T-Rock thermal blanket compressed over top hats, foil side down
4. Roof sheets fixed down onto top hats/battens

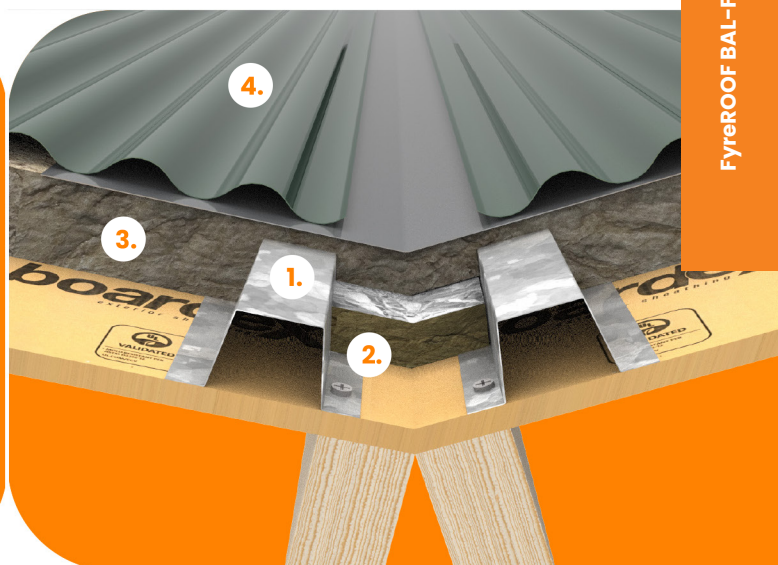

## Figure 1.4 – Ridge/hip

1. Ridge capping plugged with T-Rock thermal blanket

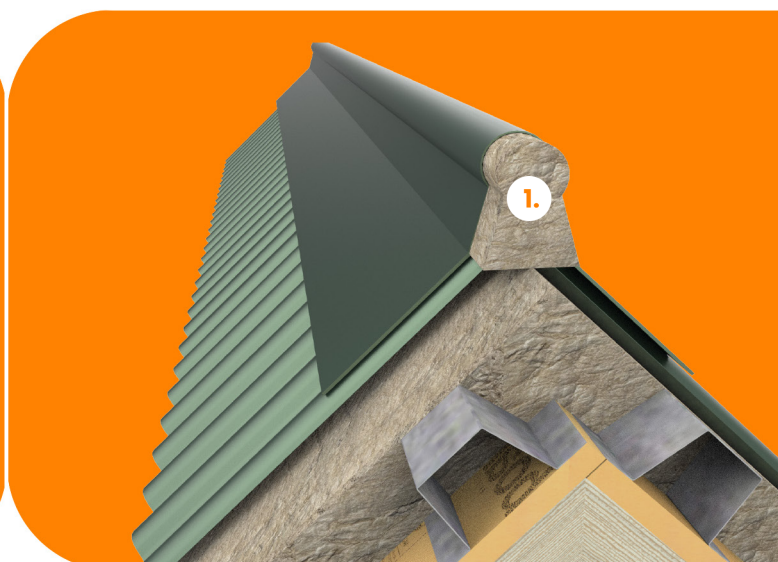

## Figure 1.5 Barge Detail

1. BoardeX wrapped around roof framing including under the return/eaves (if present).
2. T-board wrapped around the BoardeX including under the return/eaves (if present).
3. T-Rock thermal lagging applied and finished at the edge of the barge
4. Barge cap and fascia boards installed as per standard fixings and brackets
5. Top hat fixed through Siderise boards for eave boards (if present)
6. FC sheet eaves sheeted back into the wall



# SYSTEM RANGE

## Components supplied by Trafalgar

Component	Description	Item Code	Packaging
BoardeX	15mm thick BoardeX rigid vapour permiable fire board with orange fibre matt face 2400x1200mm	BoardeX-15	40x boards to a pallet
T- Board	Siderise foil faced insulation board - 2000 length x 1180 width x 25mm thickness	SIDERISE-CW-FB	32x boards to a pallet
T-Stop	Polyurethane sealant 600ml sausage	TREMstop PU+	20x Sausages per box
T-Rock	Thernal wool blanket Insulation foil faced on one side only, 50 mm thick in a roll 1.2 m wide x 4 m long	T-Rock-50	15 x Rolls per pallet

## Components supplied by Others

### Component

Fascia boards and brackets

Ridge caps

Flashings

Screws for Timber and Metal Frames  
Staples for Timber Frames

Gutters

Roof sheetings and tiles

Top hats and brackets



## HEALTH AND SAFETY

BoardeX Roof and stonewool based insulations products like T-Rock and T-Board are excellent insulation materials and are safe to use under all conditions. Insulation materials have been in worldwide use for over 70 years, and during that time their manufacture and use have been extensively monitored and researched.

For more information and MSDS documentation please refer to [www.tfire.com.au](http://www.tfire.com.au)

## FAQ

Q Do I need to install sarking with your roof system?

A No, BoardeX is a vapour permeable, rigid air barrier

Q Can I use the BoardeX roof system with tiled roofs?

A Yes, the system is approved for steel profile and tiled roof finishes

Q Can I put service penetrations through the FyreROOF?

A No, please route services elsewhere to avoid penetrating the BAL-FZ roof system.

Q Do I need to seal the joints in the BoardeX boards?

A Yes, the joint should be sealed with the T-Stop sealant to provide a fire and temporary weather seal

Q How long can I leave the BoardeX boards exposed before sheeting the roof?

A BoardeX has been shown to remain exposed without degradation for 12 months at the Trafalgar head office in Sydney

Q How do you cut BoardeX?

A It can be scored and snapped similar to plasterboard, or cut with hand/power tools

Q Can I use BoardeX as a bushfire wall system?

A Yes, there is a BoardeX wall system tested for an FRL of -/30/30. Contact Trafalgar for more details



1800 888 714 | [www.tfire.com.au](http://www.tfire.com.au)



Bushfire Solutions

Trafalgar Fire reserves the right to change specifications without notice. Please check with your supplier at the time of order. The information contained in this Product Manual was correct at the time of publication. E&OE.